

Ferd. Mayer & Sohn, Carl-Lith. 95 & 98, Fulda, S. M. A.



MATERIAL DE LA ARTILLERIA PRUSIANA.

PL.V

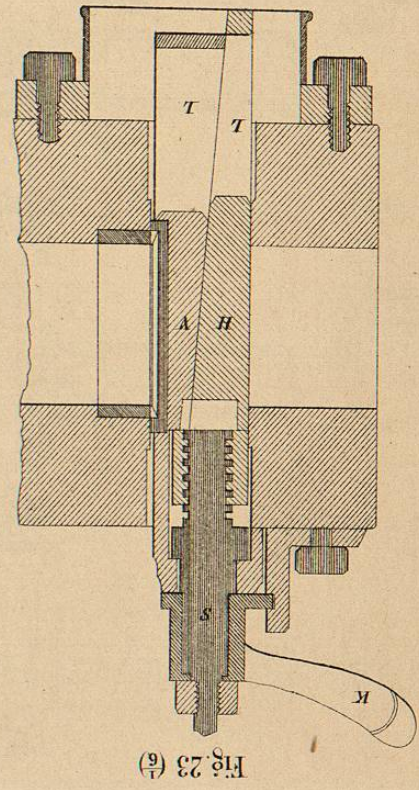

Fig. 23 (a)

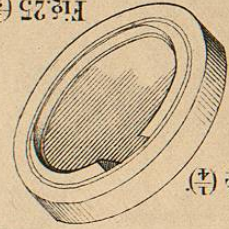

Fig. 24 (a)

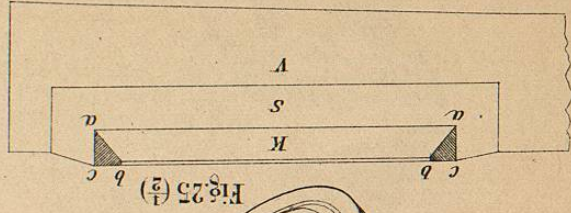

Fig. 25 (a)



MATERIAL DE LA ARTILLERIA PRUSIANA.

PL. VI

Fig. 26 (2)

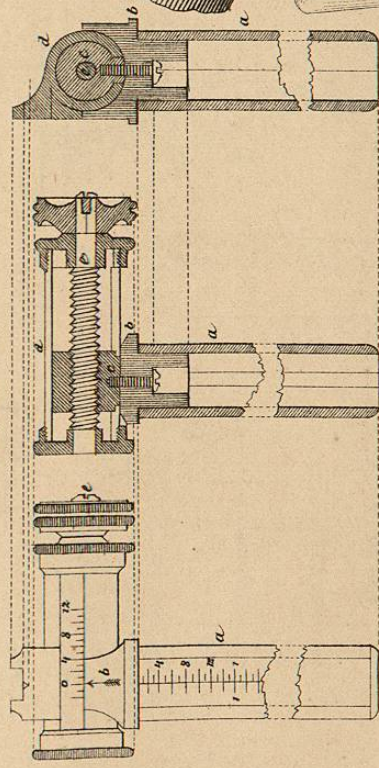

Fig. 28 (3)

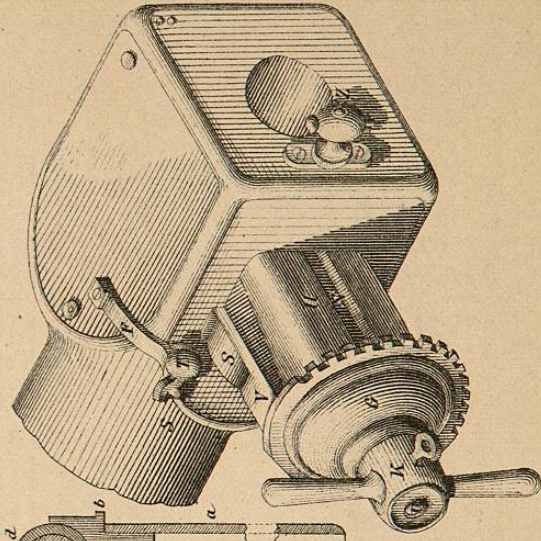
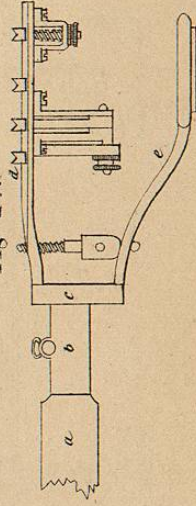
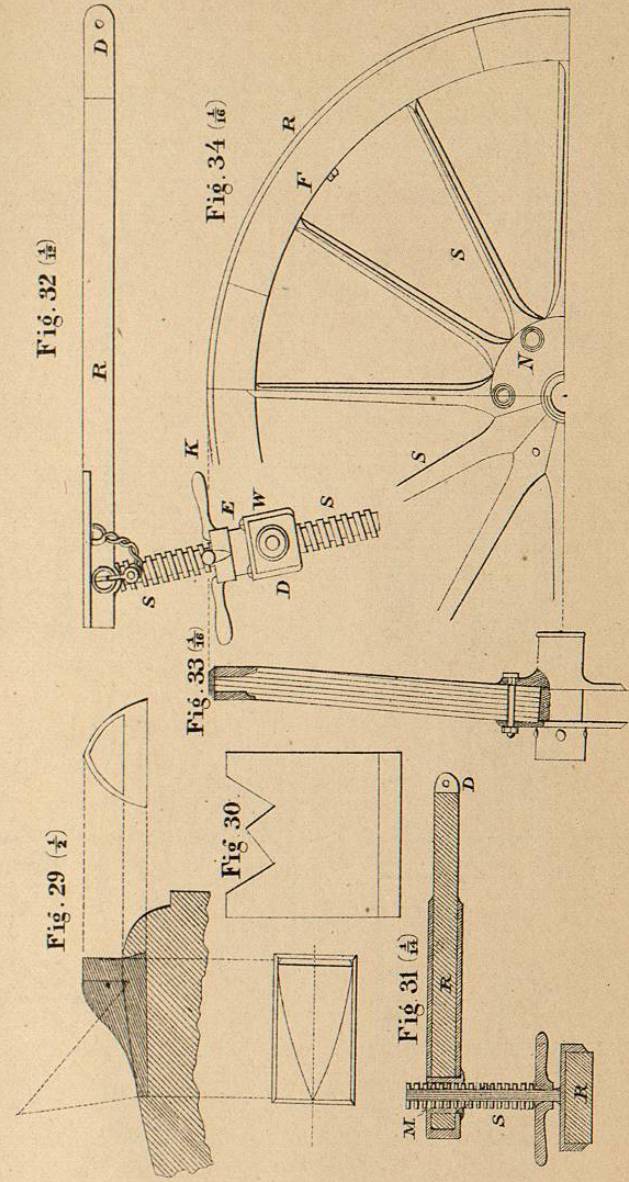
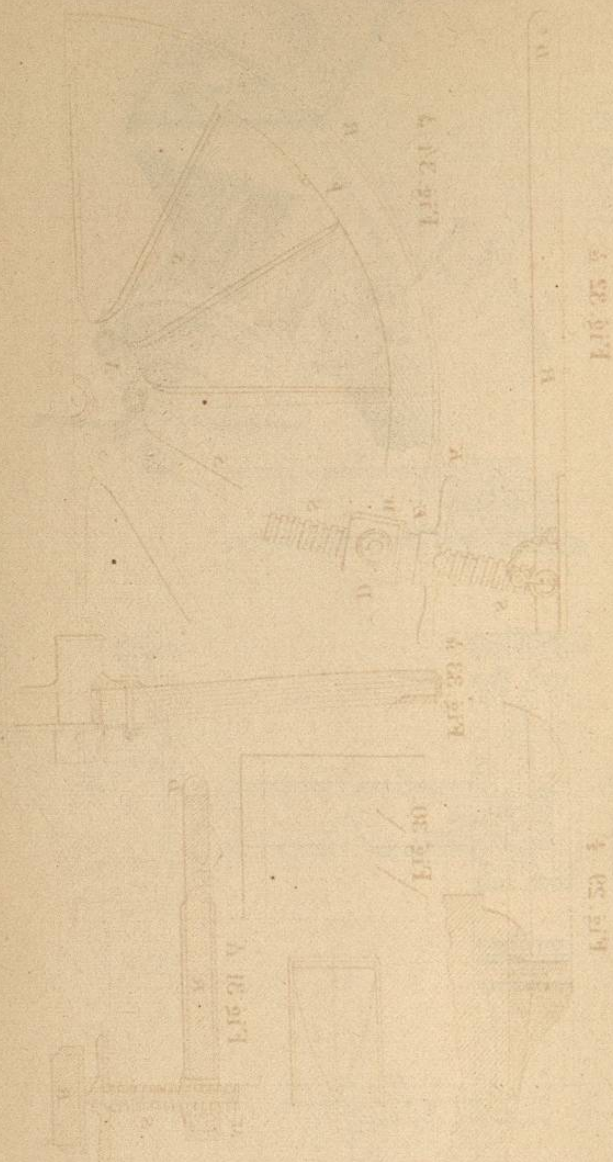

Fig. 27.









MATERIAL DE LA ARTILLERIA PRUSIANA.

PL. VIII

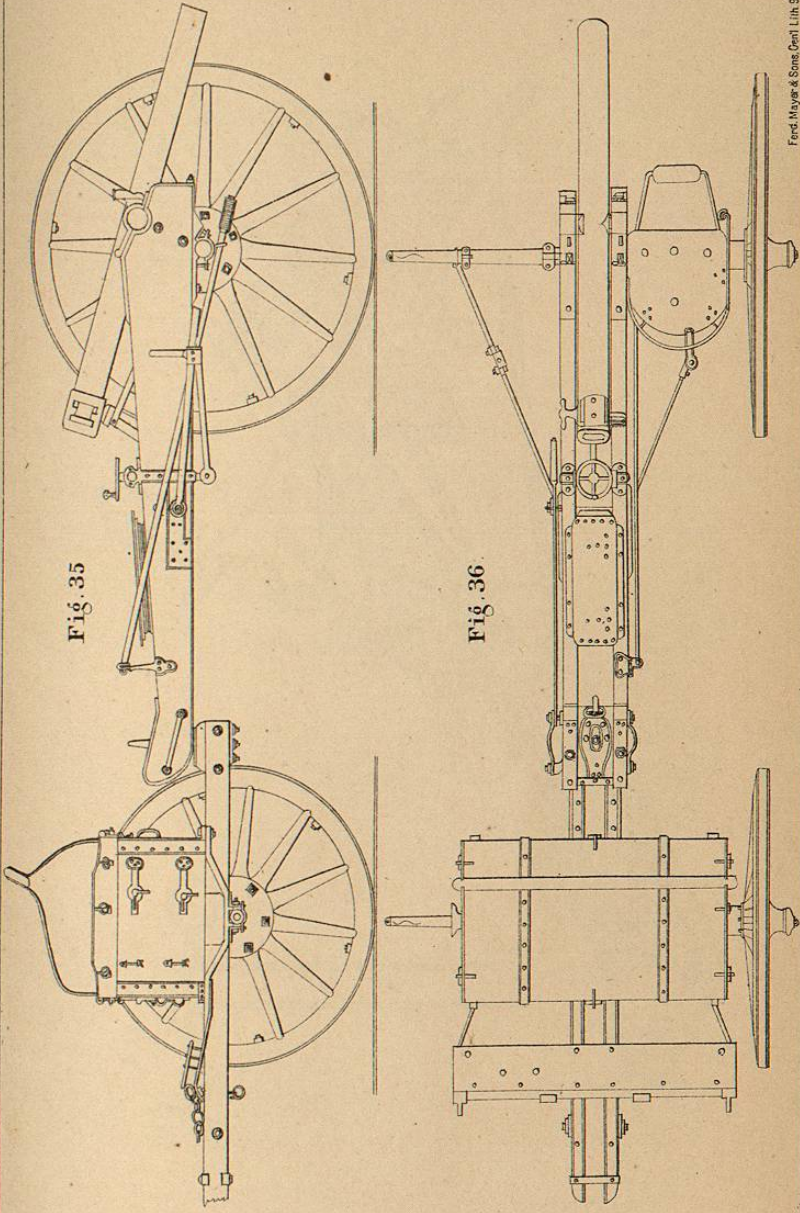

Fig. 35

Fig. 36



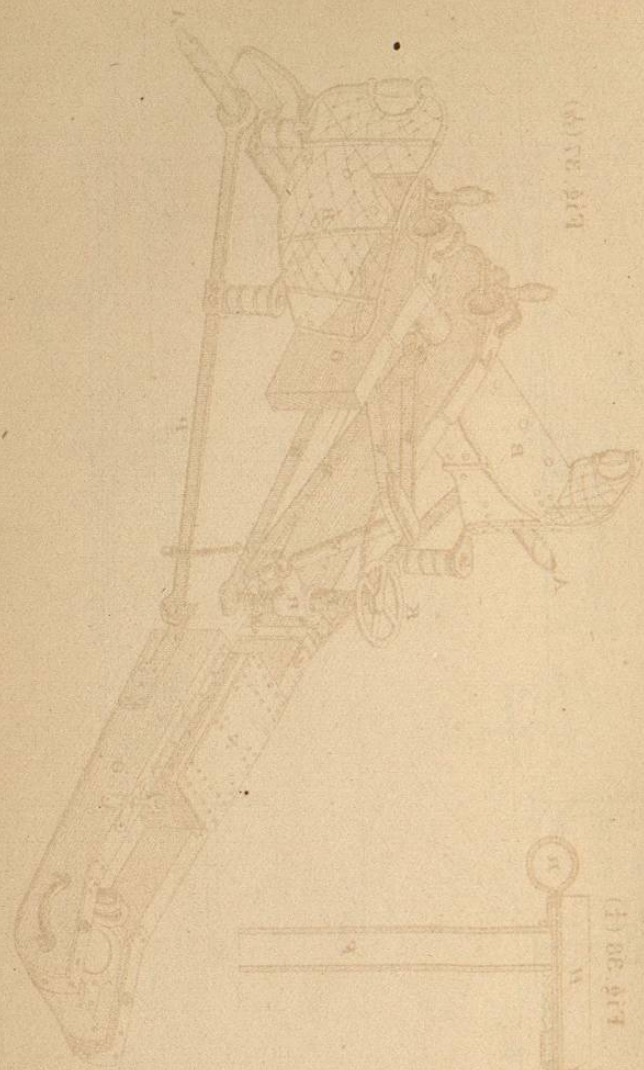

Fig. 35 (P)

Fig. 38 (P)

PL. IX

BIBLIOTHÈQUE DE L'ARTILLERIE PRUSIENNE

MATERIAL DE LA ARTILLERIA PRUSIANA.

PL. IX

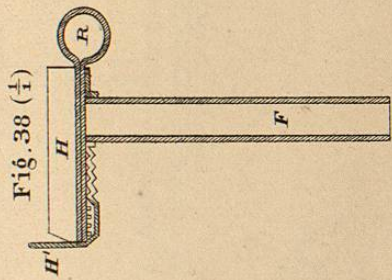

Fig. 38 (1/2)

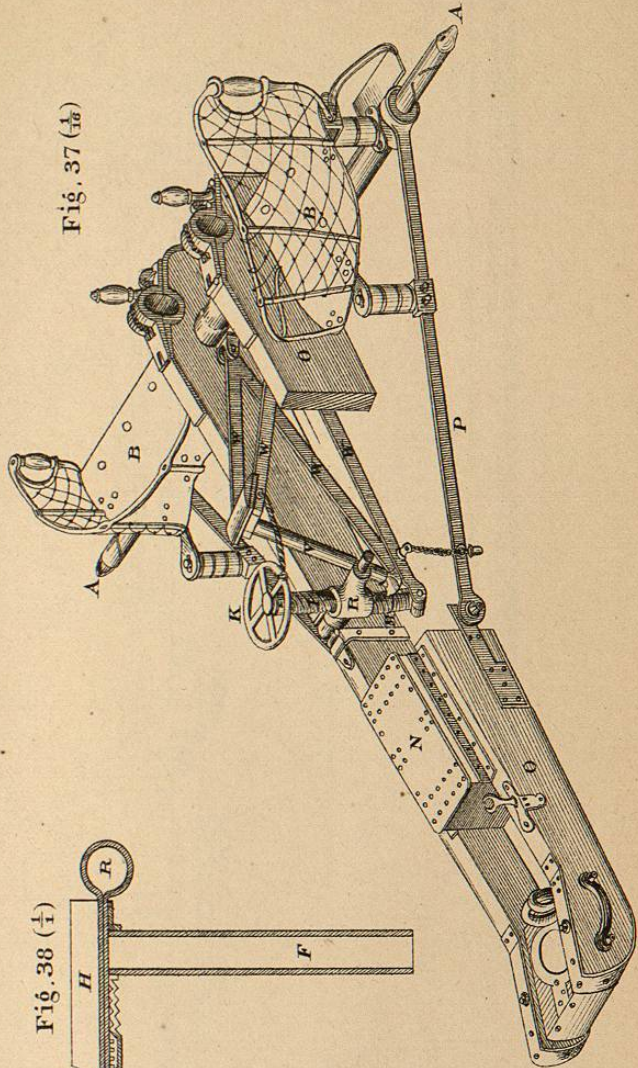

Fig. 37 (1/2)

Ferd. Meyer & Sohn, Genl. Lith. 58 & 59, Fullen St. N.Y.



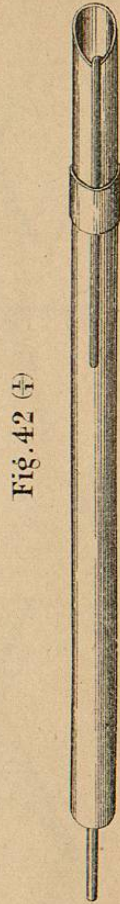
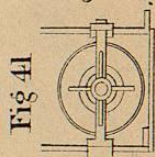
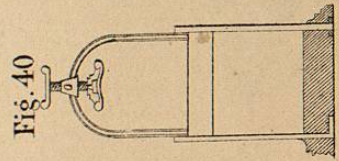
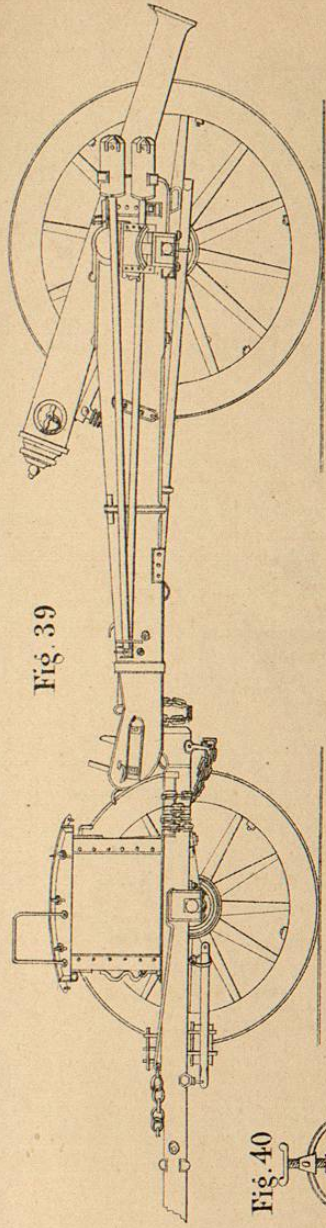





Fig. 43

Fig. 44

PL. XI

MATERIAL DE LA ARTILLERIA PRUSIANA

MATERIAL DE LA ARTILLERIA PRUSIANA.

PL. XI

Fig. 43 (36)

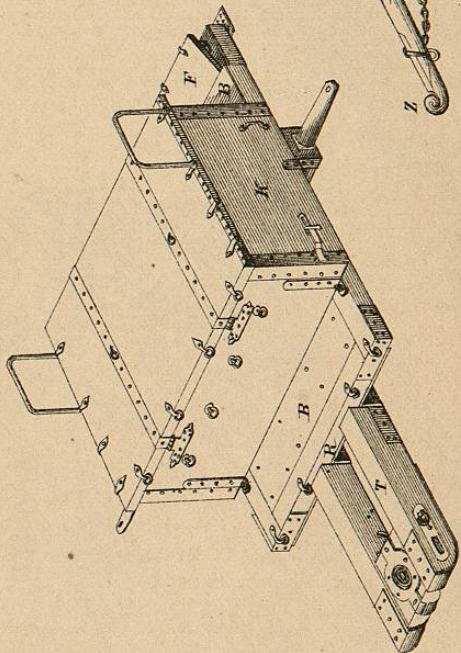
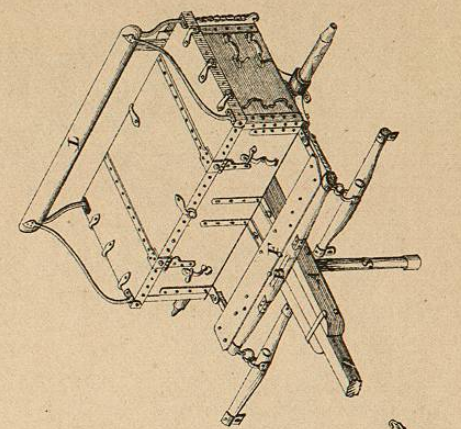

Fig. 44 (36)



Ferd. Meyer & Sons, Grt. Brit. Lit. & Col. Print. S. N. Y.